

ENCODER ASSOLUTI per BUS di CAMPO – FIELD BUS ABSOLUTE ENCODERS

I trasduttori della serie BUS di CAMPO sono encoder assoluti monogiro (S) o multigiro (M) con interfaccia per collegarsi al bus di campo secondo gli standard PROFIBUS, INTERBUS, CANopen o DeviceNet.

The encoders of the FIELD BUSSES series are absolute Single-turn (S) or Multi-turn (M) shaft encoders with an interface to connect to field bus systems according to PROFIBUS, INTERBUS, CANopen or DeviceNet standards.

F58HP

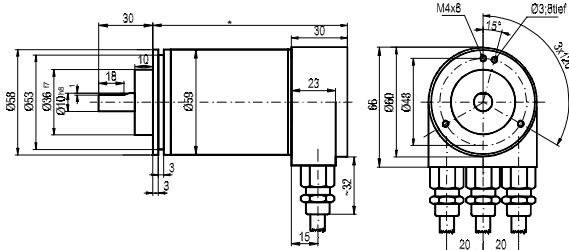

Peso: (S) circa 500 g. (M) circa 700 g
Protezione: IP65
Interfaccia: PROFIBUS
Alimentazione: 10 ÷ 30V
Risoluzione max.: 8192 X 4096
Codici: Binario

Weight: (S) about 500 g. (M) about 700 g.
Protection: IP65
Interface: PROFIBUS
Power supply: 10 ÷ 30V
Max. resolution.: 8192 X 4096
Code: Binary

F58SP

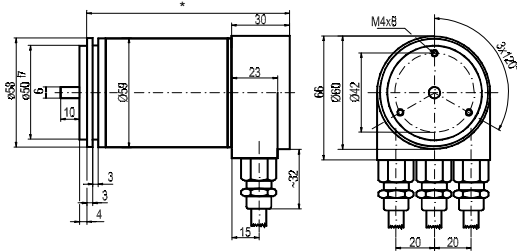

Peso: (S) circa 500 g. (M) circa 700 g
Protezione: IP65
Interfaccia: PROFIBUS
Alimentazione: 10 ÷ 30V
Risoluzione max.: 8192 X 4096
Codici: Binario

Weight: (S) about 500 g. (M) about 700 g.
Protection: IP65
Interface: PROFIBUS
Power supply: 10 ÷ 30V
Max. resolution.: 8192 X 4096
Code: Binary

F58HC

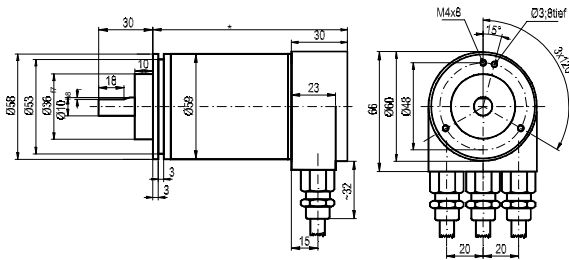

Peso: (S) circa 500 g. (M) circa 700 g
Protezione: IP65
Interfaccia: CANopen
Alimentazione: 10 ÷ 30V
Risoluzione max.: 8192 X 4096
Codici: Binario

Weight: (S) about 500 g. (M) about 700 g.
Protection: IP65
Interface: CANopen
Power supply: 10 ÷ 30V
Max. resolution.: 8192 X 4096
Code: Binary

F58SC

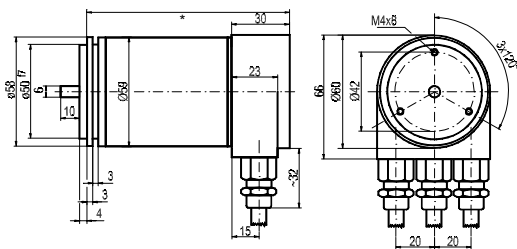

Peso: (S) circa 500 g. (M) circa 700 g
Protezione: IP65
Interfaccia: CANopen
Alimentazione: 10 ÷ 30V
Risoluzione max.: 8192 X 4096
Codici: Binario

Weight: (S) about 500 g. (M) about 700 g.
Protection: IP65
Interface: PROFIBUS
Power supply: 10 ÷ 30V
Max. resolution.: 8192 X 4096
Code: Binary

F58HD

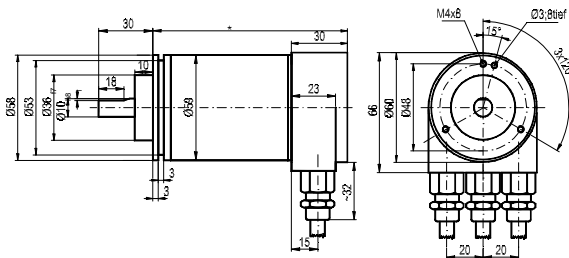

Peso: (S) circa 500 g. (M) circa 700 g
Protezione: IP65
Interfaccia: DeviceNet
Alimentazione: 10 ÷ 30V
Risoluzione max.: 8192 X 4096
Codici: Binario

Weight: (S) about 500 g. (M) about 700 g.
Protection: IP65
Interface: DeviceNet
Power supply: 10 ÷ 30V
Max. resolution.: 8192 X 4096
Code: Binary

F58SD

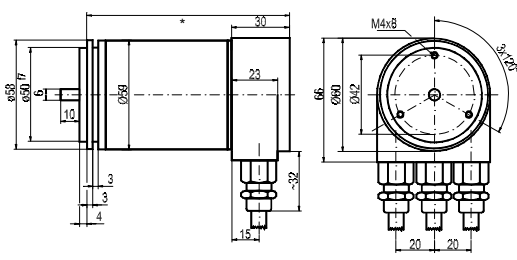

Peso: (S) circa 500 g. (M) circa 700 g
Protezione: IP65
Interfaccia: DeviceNet
Alimentazione: 10 ÷ 30V
Risoluzione max.: 8192 X 4096
Codici: Binario

Weight: (S) about 500 g. (M) about 700 g.
Protection: IP65
Interface: DeviceNet
Power supply: 10 ÷ 30V
Max. resolution.: 8192 X 4096
Code: Binary

F58HK

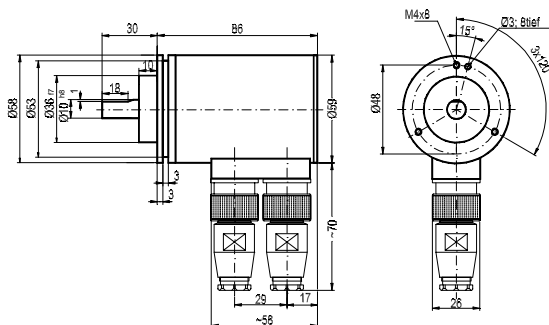

Peso: (S) circa 500 g. (M) circa 700 g
Protezione: IP65
Interfaccia: INTERBUS
Alimentazione: 10 ÷ 30V
Risoluzione max.: 8192 X 4096
Codici: Binario

Weight: (S) about 500 g. (M) about 700 g.
Protection: IP65
Interface: INTERBUS
Power supply: 10 ÷ 30V
Max. resolution.: 8192 X 4096
Code: Binary

F58SK

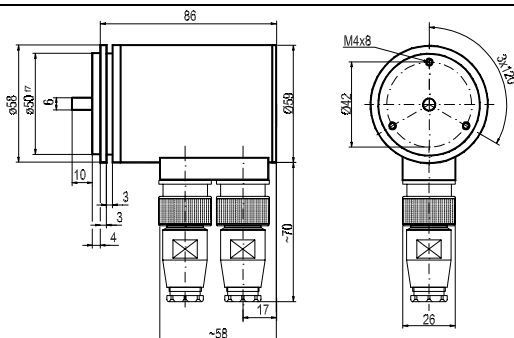

Peso: (S) circa 500 g. (M) circa 700 g
Protezione: IP65
Interfaccia: INTERBUS
Alimentazione: 10 ÷ 30V
Risoluzione max.: 8192 X 4096
Codici: Binario

Weight: (S) about 500 g. (M) about 700 g.
Protection: IP65
Interface: INTERBUS
Power supply: 10 ÷ 30V
Max. resolution.: 8192 X 4096
Code: Binary



Sta. Virgilia 29 Local.1A 28033 Madrid
Tfno.: 91 764 21 00 Fax.: 91 764 21 32
www.guemisa.com Email.: info@guemisa.com